

AB-7.5T-64KPH/LIFT-OUT BOLLARD

Able to absorb the impact of a 7.5 tonne hostile vehicle at up to 64 kilometres per-hour, the Trident AB-7.5T-64KPH Lift-Out Bollard provides security and safety to pedestrians. The strength of this lift-out bollard resides in its 254mm core, while its stainless steel finish compliments the aesthetics of its surrounding area. These Shallow Mounted protective Bollards are also rated in accordance with IWA-14.1 Standards.

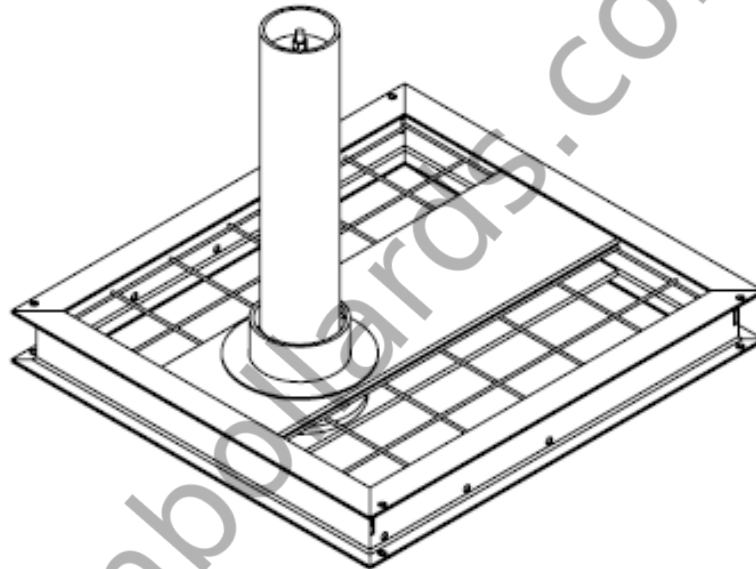

Sleeve Material	Grade 316 Stainless Steel
Sleeve Finish	Brushed
Core Diameter (mm)	254
Height Above Ground (mm)	856
Excavation Depth (mm)	162